

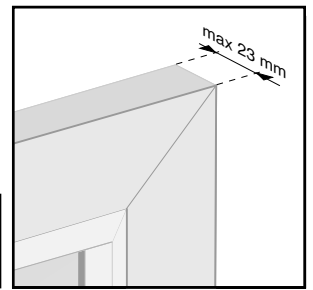

PLISSEE4YOU

Achtung:

Die maximale Rahmenstärke bei einer Montage mit PVC Klemmträgern beträgt 23 mm



Plissee Basic Modell PB2

Montage auf dem Rahmen mittels Klemmträger
(ohne Bohren)

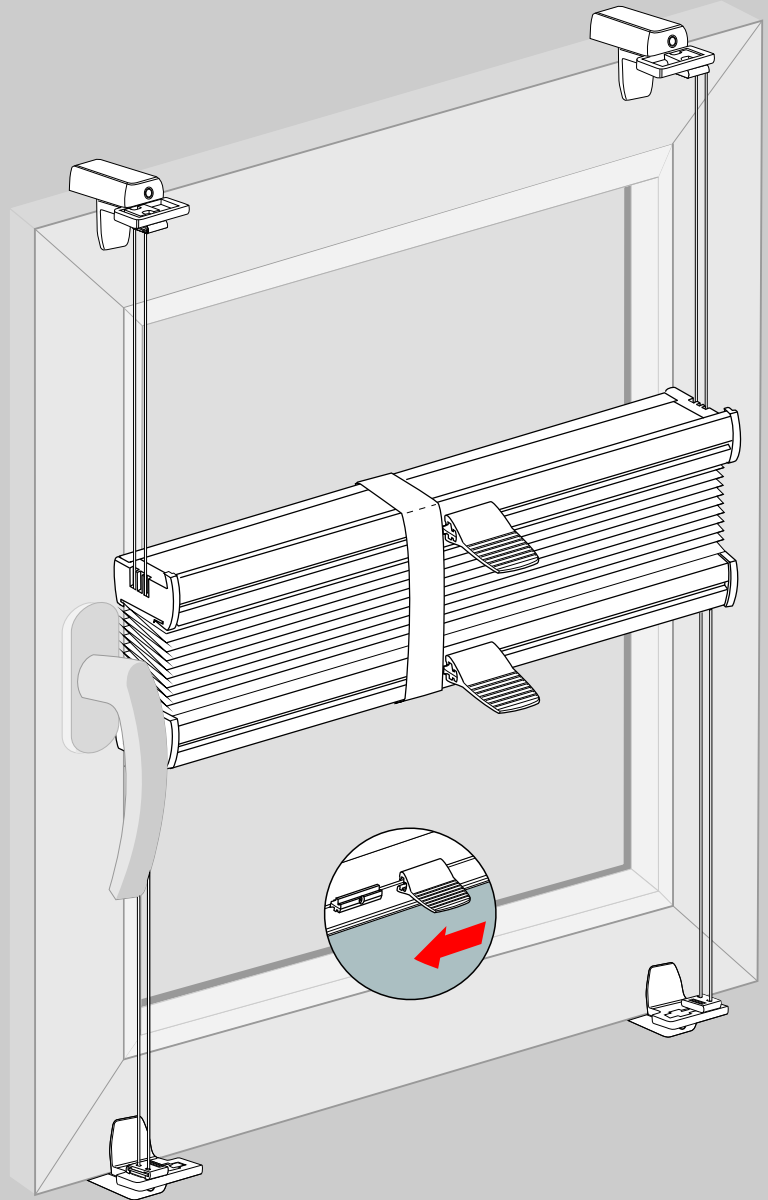
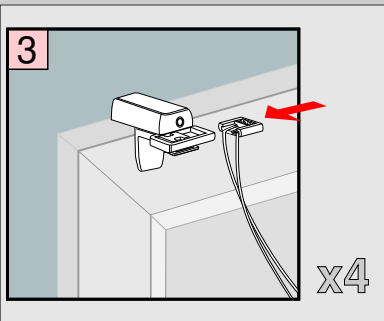
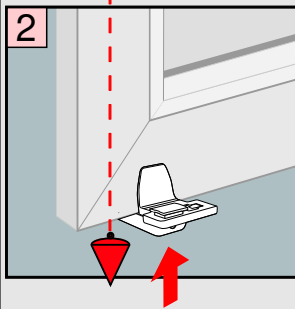
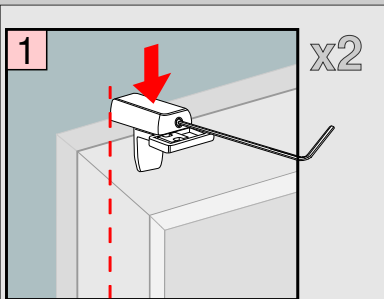
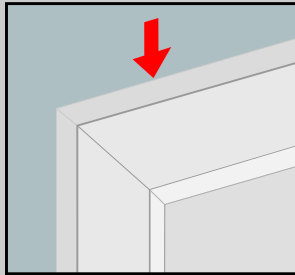
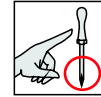

Stellung des Klemmträgers

RICHTIG

FALSCH

